

OSx

Oxygen Sensor for gas
and biomass burner

FKK

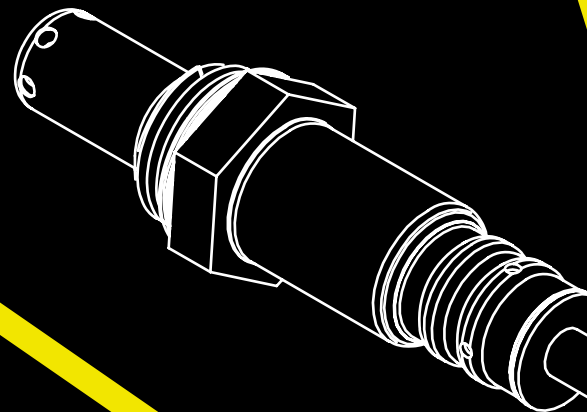
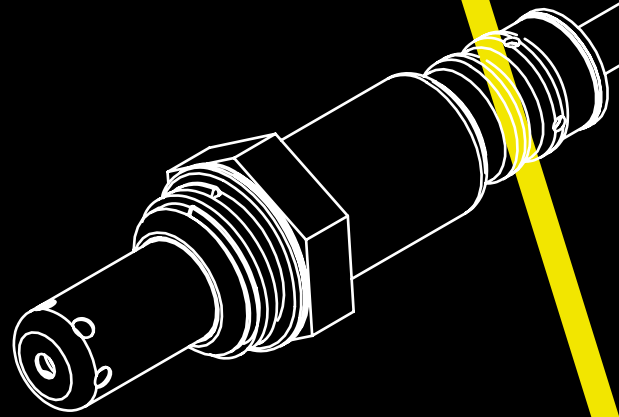
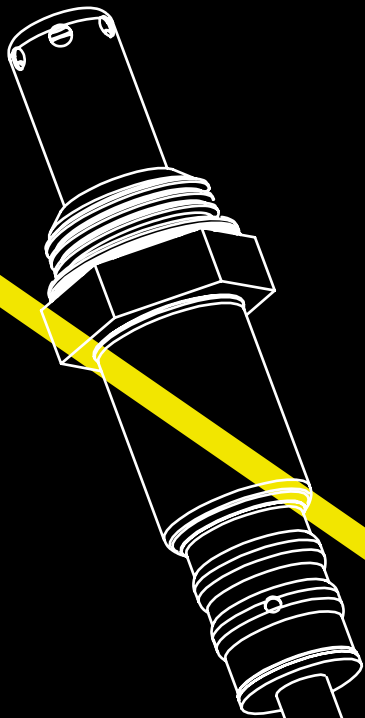
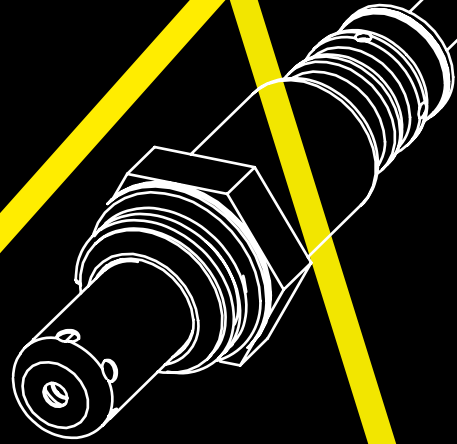
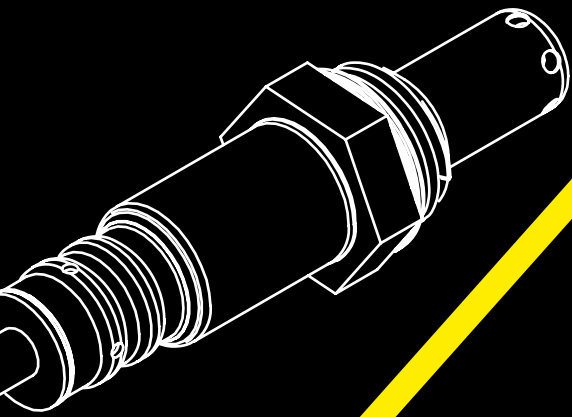

Burner Lambda Sensor

Biomass burner (wood pellet, chips, log, etc) and gas burner oxygen sensor

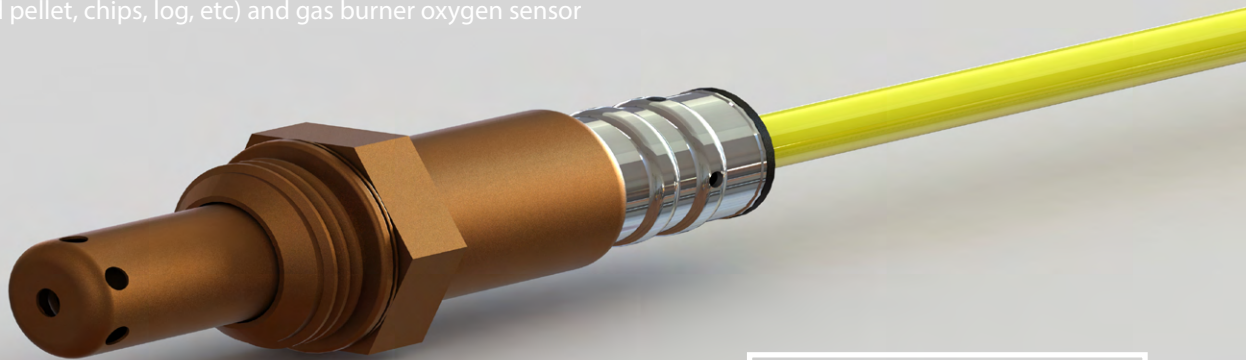

Narrow band

Built-in heater

Made in Japan

Introducing the OSx Oxygen Sensor made for biomass and gas burner, an advance technology to maximize burner performance and fuel efficiency while reducing harmful emissions.

The OSx oxygen sensor have been designed by DENSO Corporation in cooperation with FKK Corporation to measure the proportion of unburned oxygen in exhaust gases of biomass, especially wood pellet burner and gas burner systems.

This oxygen sensor with integrated zirconium heater, provide an output signal in the range of lambda and make it capable of being used as universal lambda sensor in every biomass or gas burning appliances.

What role do lambda sensors play?

In order to reduce emissions, modern biomass boiler or gas burner have been designed to carefully control the amount of solid fuel they burn.

The Lambda (or Oxygen) Sensor is a critical component in this process, its goal is to work together with the boiler's auger, inlet and exhaust air fan and electronic control unit (ECU) to achieve the lowest possible output of environmentally harmful exhaust gas emissions and biomass fuel consumption whatever the fuel quality. In gas appliances it allow an optimum combustion.

The Lambda Sensor does this by monitoring the percentage of unburned oxygen present in the burner's exhaust gases. This data is fed to the boiler's ECU, which adjusts the A/F (air/solid fuel) mixture. The correct air/solid fuel mixture enables the burner to run efficiently, reducing solid fuel consumption and CO₂, NO_x, HC emission.

Denso O2 sensor technology benefits

- Can cut solid fuel (e.g. pellet) annual consumption and emission by 20%
- Detects a broad range of air-fuel ratio up to 21%
- Allow an easy adaptation whatever fuel quality (pellet or gas family)
- Long lasting (non-aging)
- built-in heater to run at all exhaust gases temperatures
- Impervious to oxidation and corrosion
- Excellent water resistance and air tightness
- Comply with RoHS, REACH regulation on Hazardous Substances
- 100% checked before shipment
- Made in Japan

Systems

- Wood pellet boiler
- Wood Pellet burner
- Wood chips boiler
- Wood log boiler
- Residential gas burner
- Commercial gas burner
- Industrial gas burner

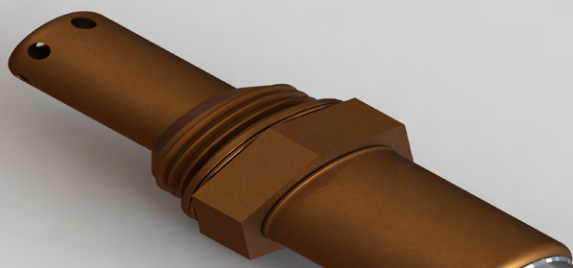

Optimum combustion with Air / Fuel monitoring

To obtain optimum combustion it is necessary to supply the burner with the exact quantity of air in function of the amount of fuel (e.g pellets or gas) to burn. The overall excess air ratio should be kept as low as possible to achieve high efficiency.

The OSx lambda sensor measure this ratio and allow the burner to achieve the best efficiency while stabilizing the burner output whatever the fuel quality or gas family class or weather. This technology can allow a saving of as much as 20% of annual consumption of wood pellet and allow a substantial decrease of harmful emissions (CO₂, NO_x, HC, etc).

Air / fuel vs. Efficiency

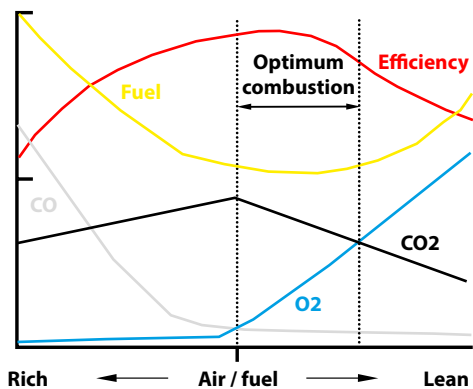

Regulate & Optimize

The oxygen sensor allow to regulate air and combustible load over the time to achieve a stable and optimum combustion, whatever the season and humidity of the solid combustible.

OSx-1

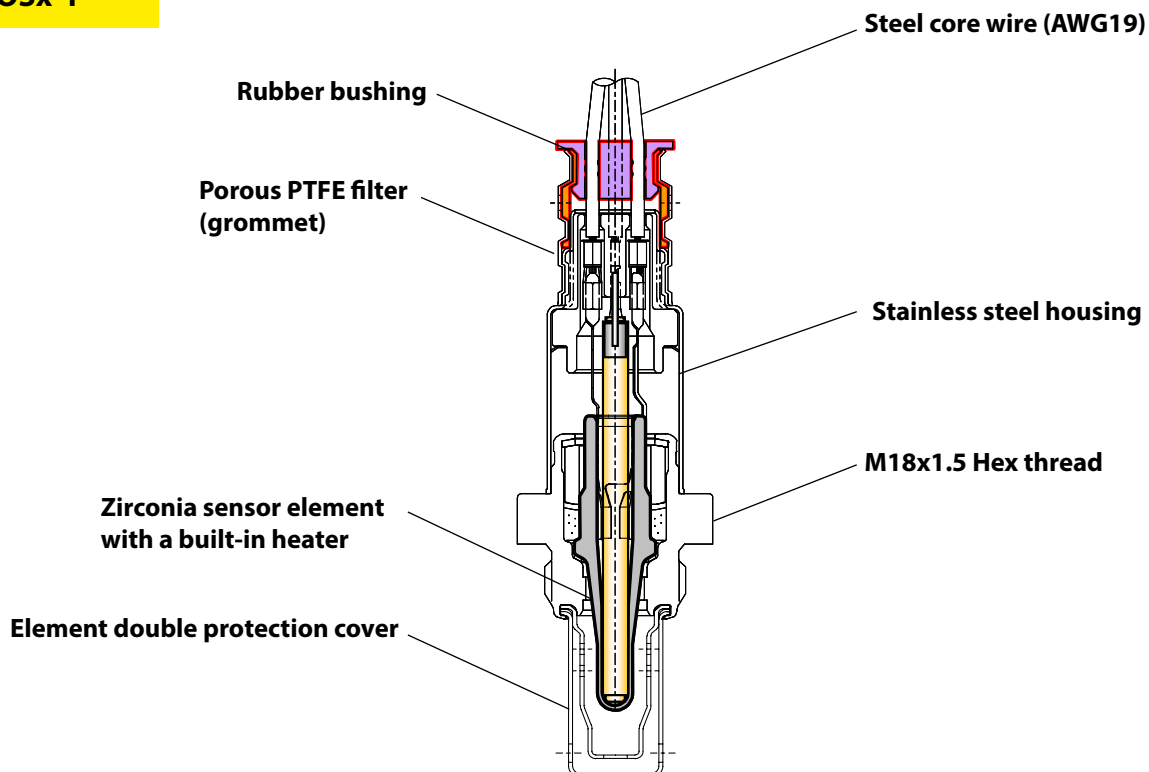

The advanced design of DENSO Lambda Sensors eliminates oxidation and corrosion problem. The unique aluminum oxide double trap layer surrounding the sensor's ceramic element protects it from problem of fuel and maintaining its lifespan and efficient performance.

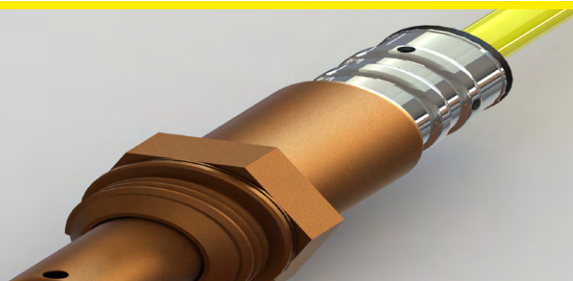

OSx Oxygen sensors

The best way to improve heating appliances efficiency.

Application

Sensor suitable for monitoring of wood pellet, chips, logs, wood chips, coal, straw stoves and other biomass boilers and burners.

Features

Mechanical characteristics

Weight	78g
Thread	M18x15
Wrench size	22mm
Tightening torque	45±5 Nm

Electrical characteristics

System supply voltage (DC/AC)	9-12V
Heater power steady state	9-12W
Heater control frequency	≥ 10Hz
Max current load for sensor	≤ 5mA

Sensor output characteristics

Signal output (DC)	mV
Lambda control range (special application)	1.0...2.0 λ up to 2.0
Accuracy at lambda 1	±0.02
Sensor output voltage for 1.05...2.15 λ 220 °C and flow rate of 30l/min	48...6 mV
Sensor output voltage in air (21% O ₂)	-4...-10 mV
Rich mixture voltage (VR)	≥ 700mV (0.9λ)
Lean mixture voltage (VL)	≤ 200mV (1.1λ)
Response time T _f	≤ 860ms

Based on 400°C temperature at sensor tip and 3.0m/s gas velocity condition.

Application environmental conditions

Exhaust gas temperature range (1)	≤ 900°C
Hexagon temperature (2)	< 600°C
Sensor body temperature (3)	< 350°C
Grommet temperature (4)	< 280°C
Bushing temperature (5)	< 240°C
Wire and sleeve temperature (6)	< 180°C
Terminal connector temperature (7)	< 120°C
Storage temperature range	-40 to 40°C
Max vibration	392 m/s ²

() number on picture page 7

Sensor cell characteristics

Max temperature for short time	950°C
Max temperature change rate	≤ 40°C/s
Nominal resistance	40KΩ

Built-in heater characteristics

Heater resistance at 20 °C	5.6Ω
Heater voltage (DC or AC)	9-12V
Max inrush current (-40±1°C, DC 14V)	3.02 A
Heater current (12V)	1.0 A
Max heater temperature	1000°C
Max temperature change rate	180°C/s

Dimensions

Unit (mm)

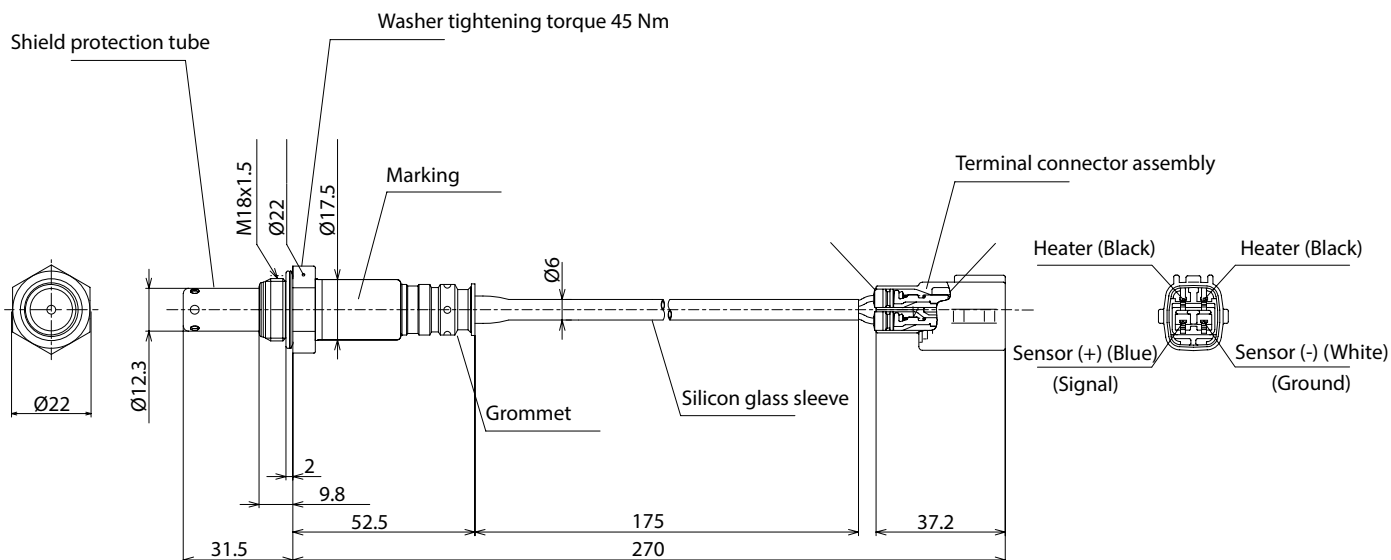

Optional connecting cable of 1~2m available upon request.

Sensor output voltage vs. O2% and λ (reference only)

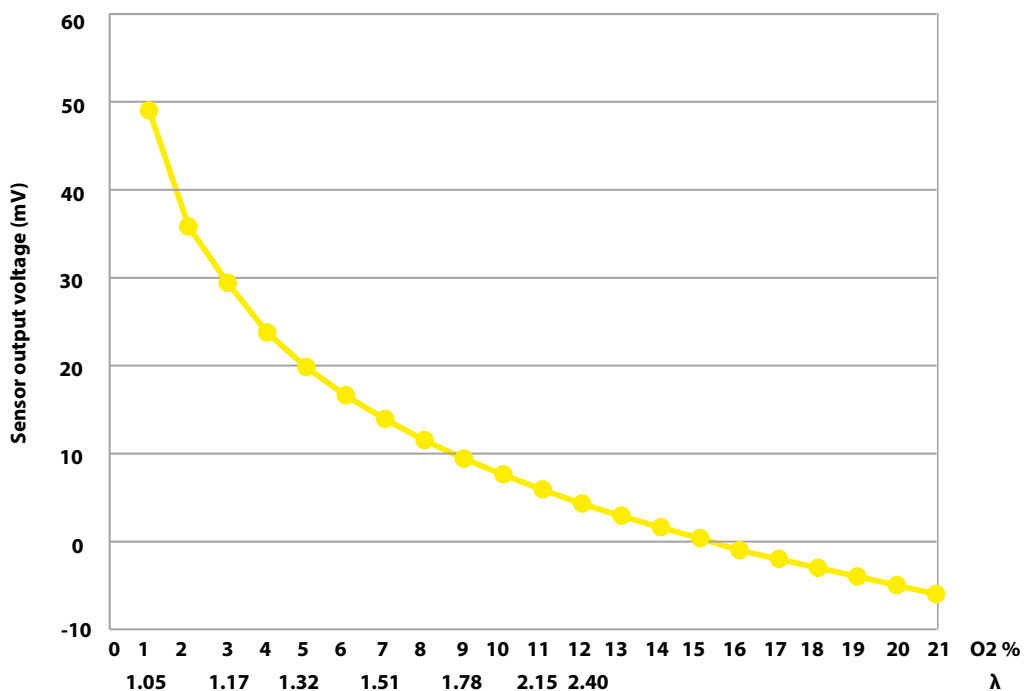

Sensor output voltage vs. λ in lean range (reference only)

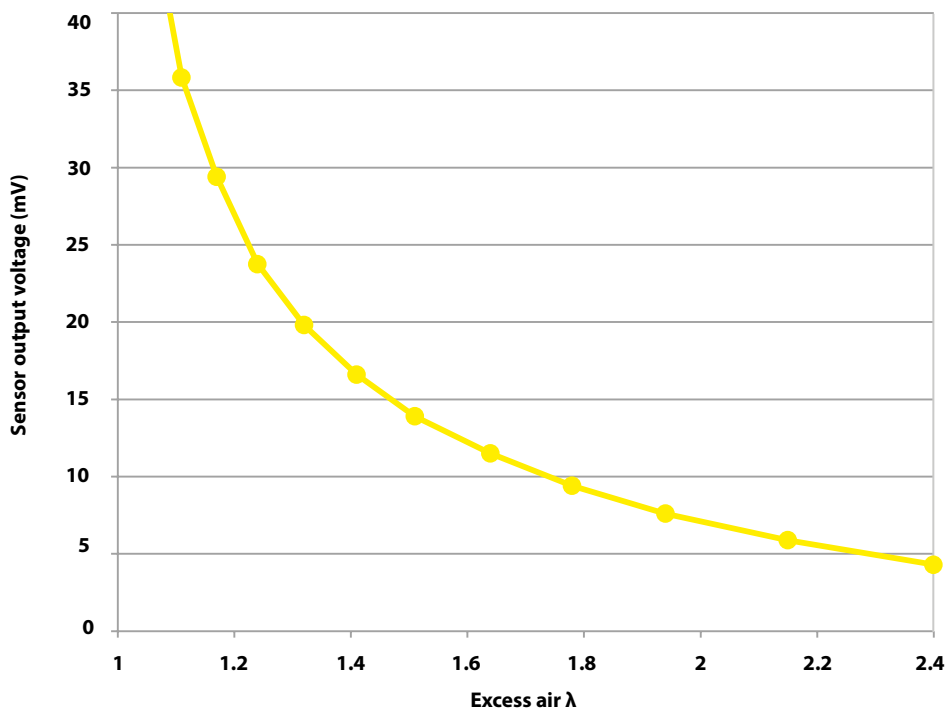

Sensor output voltage (mV)	λ	O2 %	N2 %	H2O %
146	1	0	79.9	20
49	1.05	1	78.9	20
8	1.94	10	69.9	20
-6	-	21	58.9	20

Based on 220°C temperature at sensor tip and 30 l/min gas velocity condition.

All drawings and data-sheets are available for download at : www.plug.fkk-corporation.com/en/download

You can also scan the QR code to go directly on the related page.

drawing data-sheet



Internal heater control method

The sensor element stably function at element temperature of 400°C to 900°C. In this purpose the OSx sensor integrating a built-in heater.

The heater temperature can be adjust to 600°C or less by using the following graphic data showing dependency of heater and sensor element temperature.

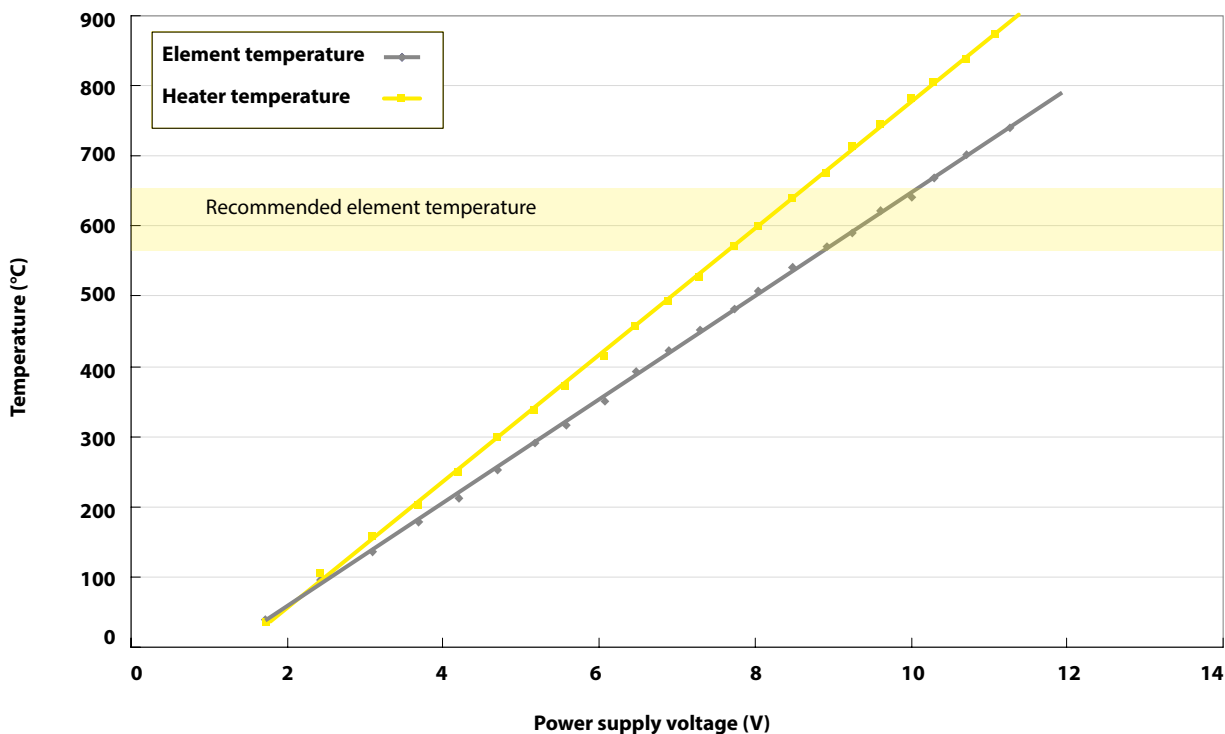

Measured temperature at 20°C. Heater temperature maximum change rate 180°C/s.

Internal heater rising temperature

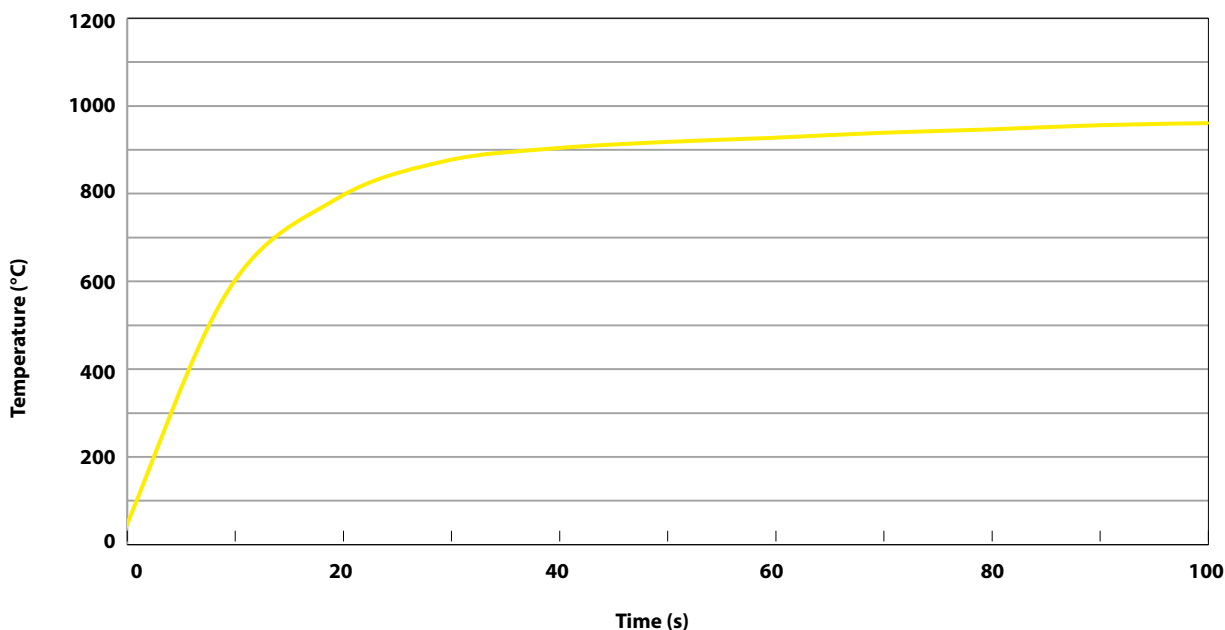

Correct handling and use



1. Sensor nose

Avoid sudden impact:

- > Avoid any sudden knocks to prevent damage to the sensitive ceramic element inside.

Avoid contamination:

- > Avoid all possible contamination, by keeping the Sensor nose free from foreign substances.
- > Do not spray anything on the Sensor nose.
- > Do not put grease on the Sensor nose.
- > Avoid the use of leaded fuel.
- > Avoid the use of fuel additives

2. Sensor body thread

Grease the thread:

- > Grease the thread with the supplied copper grease before installation.

3. Sensor body

Keep clean:

- > The back end of the Sensor contains holes, through which it breathes to sample the outside air. These holes need to stay open to enable the Sensor to function.
- > Keep the Sensor body protected from dirt and sudden cold water splashes.
- > Do not spray the Sensor with high-pressure water.
- > Keep the Sensor free from all types of coatings.

4. Grommet

5. Bushing

Avoid high heat:

- > Keep free from the exhaust-pipe or other hot burner parts.

Avoid stress:

- > Keep free from moving parts.
- > Avoid cable tension.
- > Avoid long, free-hanging cabling: it could start to swing or even get caught by other parts or objects.

6. Cable

7. Connector

Keep clean and dry:

- > Do not use grease or contact spray of any kind.
- > Moisture and other foreign substances will easily influence the sensor.

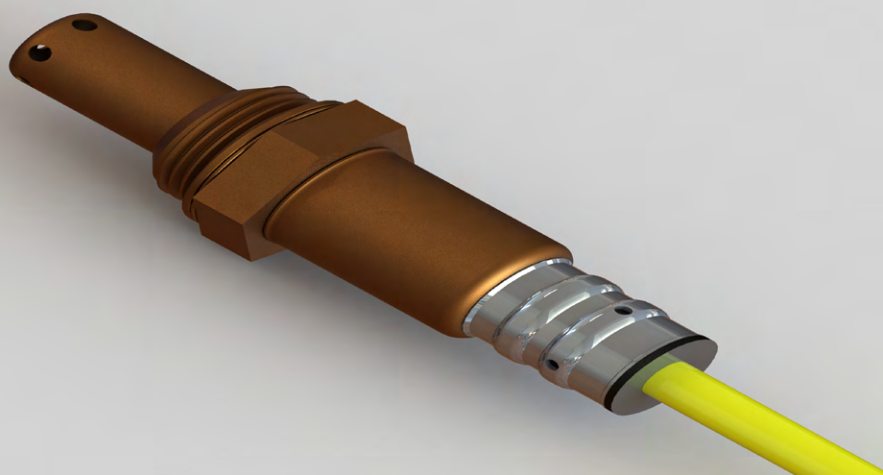

FKK corporation

www.plug.fkk-corporation.com

Fuji Kogyo Corporation (FKK) Head office / Sales

11 Tsutsumisoto-cho Kisshoin
Minami-ku, 601-8399 Kyoto, Japan

International department
TEL +81(0)75-314-8760
FAX +81(0)75-314-4167
international@fkk-corporation.com

